



Egyptian Knowledge Bank



Protection of Side Slopes of Drain in West Nile Delta: Case Study

Marawan Shahien¹, Ahmed Farouk² and Ahmad Daif³

¹ Professor, Faculty of Engineering, Tanta University, Egypt
E-mail: marawan.shahin@f-eng.tanta.edu.eg

² Ass. Professor, Faculty of Engineering, Tanta University, Egypt
E-mail: drafarouk@f-eng.tanta.edu.eg

³ Researcher, Faculty of Engineering, Tanta University, Egypt
E-mail: PG_89230@f-eng.tanta.edu.eg

ABSTRACT

Water courses (irrigation and drainage canals) are subjected to several side slope failures as a result of different reasons. These failures expose roads and facilities to damage and cause a great loss of water. This article introduces a case study of an agricultural drainage (Abu Homs drainage) which is located in the west side of the Nile Delta in Egypt. The length of this drainage is 21,600 Km running parallel to the Cairo-Alexandria road and railway track. The reasons behind the slope failures of the studied drain mainly lies in the illegal drainage carried out by farmers into the drain without using pipes, the mechanical dredging works deform the cross sections of the drains, the irregularity of the Water lifting stations in lowering the levels in an orderly manner, additional live loads, seepage forces, and erosion. Moreover, the poor quality of the dispersive soil forming the embankment was among the most important reasons of the slope failures. More than one protection method has been suggested, and each has its advantages and disadvantages. However, each site was studied separately and in details to find out the best way to deal with it even if it is on one derange.

Keywords: Side slope failures, Protection, Drainage, Seepage, Embankment.

INTRODUCTION

Stable earth slopes, both natural and man-made, are of great importance as demonstrated by the consequences of slope failures given in the Cedergren (1977).

Other investigators emphasized on the importance of the emerging seepage in failure of alluvial Monogahela River (Hamel, 1988) and the Mississippi River (Nakato and Anderson, 1998). Hagerty and Parola (2001) concluded in their study that the riprap revetments even those protected by filters might fail as a result of excessive seepage. Furthermore, leaching of salts in soil with high salt concentration leads to internal erosion and successive.

El-Ashaal, Hikal, and Abdel-Motaleb (2000) demonstrated the rehabilitation and upgrading of a cracked zoned fill dike. They indicated that the rehabilitation works were divided into two stages. The first one was to carry out urgent protection measure by providing a stabilizing mass of graded sandstone to support the dike back slope and the second one was to execute a permanent protection measure by providing a stabilizing prism of loamy sand as an extension for the berm at the upstream dike slope. Using piles to stabilize slopes has been used successfully for many years. DeBeer and Wallays (1970) reported the use of bored piles reinforced with steel beams in the stabilization of a slope. Poulous and Davis (1980) pointed out that large diameter piles (1.0 to 1.5m) were used to stabilize active landslide areas in the United States. In Japan, steel-pipe piles with 30-cm diameter were also used to stabilize landslides. Chow (1996) and Hassiotis et al. (1997) presented the design of slopes reinforced with a single

row of piles. El-Ashaal, Abdel-Motaleb, and Haggag (2000) used reinforced concrete piles to stabilize the embankment of a major canal made of uncompacted marine deposits and founded over soft clay. Despite the frequent use of piles to stabilize slopes, there has not been a standard method for the design of such piles. Stark et al. (2008) presented a case study where PVC geomembrane was successfully used to mitigate a failure in water ponds.

And we will review a drain which a field study has been made, showing the extent of its technical competence and how the cases of Side slope failures that occurred to it caused several problems and the appropriate protection that was made for it.

Monitor the problem

The Drainage Research Institute at the Egyptian General Authority for Drainage Projects conducted the study reached to The Abu Hummus Drainage follows the Egyptian General Authority for Drainage Projects extends runs from the left drain of the Al-Khairiy Drainage in the vicinity of Damanhur city in the northwestern side, And until it pours into the public Al-Omom Drainage at 5,251 km, Which in turn flows into the sucking channel of the Abu Homs lift station. Its length is about 21,161 km, and it serves 12,311 feddans agricultural land, its water drainage design is (4,97 m³ / sec.) and 156.7 million cubic meters annually. Figure 1

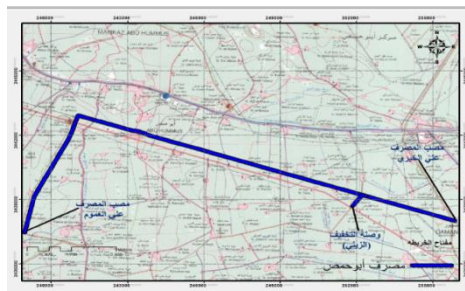

Figure 1 : Abu Hummus Drainage Path

Abu Homs drain in the west of the Nile Delta in Buhaira governorate suffers from a problem of adjacent to the Alexandria-Cairo railway to its left drain, a distance of 16 km. It makes carrying out any maintenance work for the drainage sector from dredging , or clearing weeds an impossible task, Fearing that parts of the railways would be affected and failed (according to the railways 'concerns),

it resulted in: the accumulation of sediment in the drain and the blockage of the water sector in a large proportion due to the inability to carry out maintenance work as required.

This also led to a rise in water levels in the drainage, submerged most covered drainage collectors, which in turn allowed the illegal drainage carried out by farmers into the drain without using pipes.

Leading to the deterioration of the agricultural drainage situation in the region.

It also led to the inefficiency of industrial works (Coverage, Culvert, Several bridges, Siphons, and others) Since the drainage passes through many residential blocks, it is exposed to many sources of pollution, especially with pre-treated or untreated wastewater, and also dumping solid waste (garbage and agricultural waste) on its sides. These and other reasons led to several Side slope failures of the drainage. Figure 2,3



Figure 2 : Abu Hummus Drainage failure 01- Sahaly



Figure 3 : Abu Hummus Drainage failure 02- Zwait

Objectives of the study

- Determining practical and economic solutions to reconfigure the design sectors of Abu Homs drain, which would allow achieving free drainage of the covered drainage collectors served by the drain.
- Study the effect of pollutants resulting from illegal drainage of wastewater and pollution of drainage water that led to change and decay of the sector of the drain.
- A study of the efficiency of operating industrial businesses located on the drain, including the lifting station Al-Omom drain.

Field and office work

Surveying the actual cross sections of the drain from the beginning to the downstream was done three times periodically every two months with an intersectional distance between 1000 to 2000 meters, in order to assess sedimentation or erosion rates and their relationship to time along the path of the drain. Figure 4



Figure 4 : Surveying works of Abu Hummus Drainage sectors

The actual cross sections were raised along the drain for comparison with the design sectors and collect places of slope failure. Figure 5,6 Surveying the outlet of 51 covered drainage collectors. Figure 7

Figure 5 : The actual longitudinal section of Abu Homs drain and places of slope failure

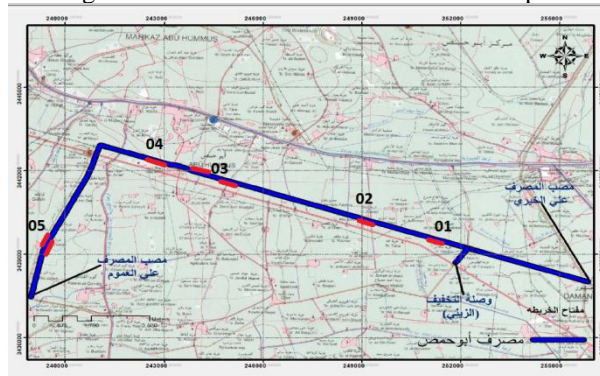

Figure 6 : places of slope failure of Abu Homs drain

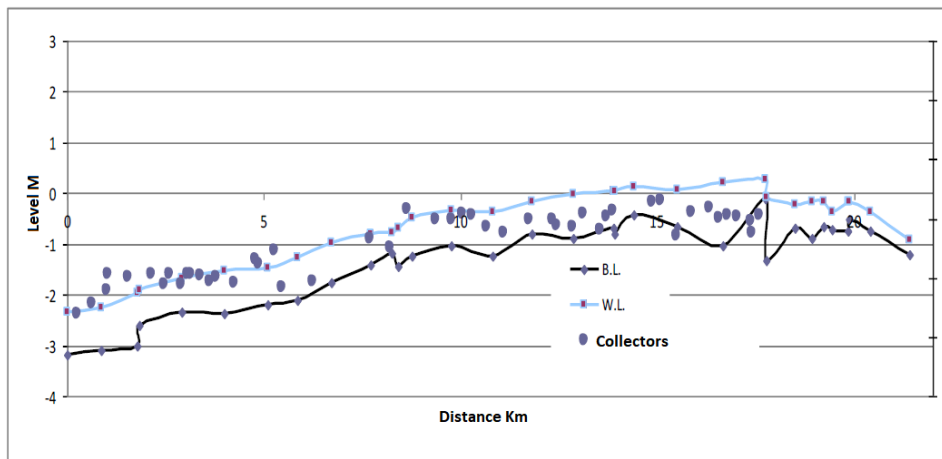

Figure 7 : The actual longitudinal section of Abu Homs drain and the condition of the covered drainage collectors

The size of the sediment, the condition of the drain, and the industrial works:

The surveying height of the drainage stream showed the magnitude of the sedimentation volume in the drain and a rise in the actual bottom level of the drain in front of all industrial work such as the culvert at the bottom of the railway and in front of the Siphons under the Qinawiya canal.

In front of the coverage at the entrance to the city of Abu Homs, the average height at the bottom of the drain is 1.15 meters and up the height at the bottom of the drain is 1.59 meters (Table 1)

The reasons for the increase in sedimentation rates and quantities are due to failure to carry out maintenance of the drain in the best way that is recognized by the rest of the region's drains, due to the Railways Authority's reservations on any civil works in the Abu Homs drainage route, for fear of the collapse of the left embankment running parallel to the railway line. Table 1, Figure 8,9

حجم الترسيب بالمتر المكعب	عرض القاع (م)	أرتفاع الترسيب (م)	القاع الفعلي	القاع التصميمي	الكيلو متر	الموقع
37130	5	0.75	-3.2	-3.95	0.00	المصب علي العموم
		0.73	-3.1	-3.83	0.86	
		0.70	-3	-3.70	1.78	بعد اختناق في المصرف (امام قرية الطواله)
		1.07	-2.62	-3.69	1.84	قبل اختناق في المصرف (امام قرية الطواله)
		1.01	-2.38	-3.39	4.00	
		1.03	-2.1	-3.13	5.84	قبل بربخ السكة الحديد (دوران المصرف)
		1.54	-1.41	-2.95	6.71	قبل سحارة ترعة القناوية
		1.06	-1.75	-2.81	7.7	
27600	4	1.13	-1.7	-2.83	7.9	
		1.33	-1.45	-2.78	8.25	بعد التغطية (مدينة ابوحمص)
		1.59	-1.17	-2.76	8.41	قبل التغطية (مدينة ابوحمص)
		1.47	-1.24	-2.71	8.76	
		1.17	-1.25	-2.42	10.82	
		1.24	-0.9	-2.14	12.86	
7009	3	1.20	-0.8	-2.00	13.8	بعد البداله (المارة فوق المصرف)
		1.17	-0.7	-1.87	13.9	قبل البداله (المارة فوق المصرف)
		1.36	-0.43	-1.79	14.4	اختناق للمصرف عند سحالي
		0.37	-1.03	-1.40	16.67	
		0.05	-1.17	-1.22	17.73	ميدا المصرف الي العموم

Table No. (1) : The volume of sediment in the Abu Homs drain from Km 17,681 up to the downstream Omom Drainage

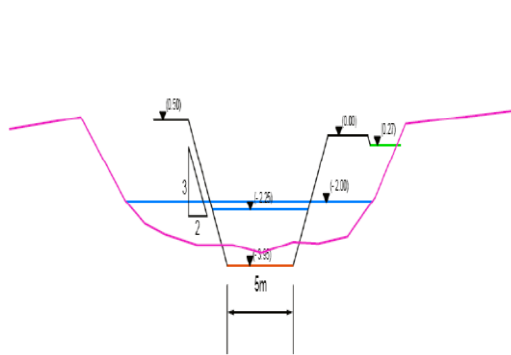

Figure 8 : Cross section of Abu Hummus Drainage failure 01-Sahaly

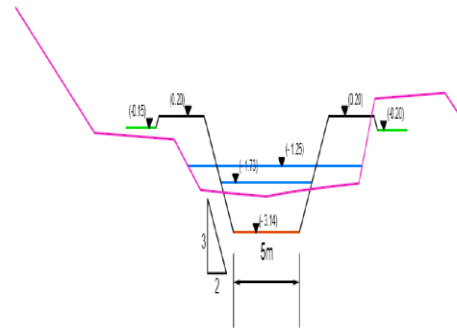

Figure 9 : Cross section Abu Hummus Drainage failure 02- Zwail

Soil investigation

At places of failure mechanical rotary boring samples taken at a depth of 20 meters, and disturbing and non-disturbing samples were extracted for each one accumulated in the soil profile. Figure 10

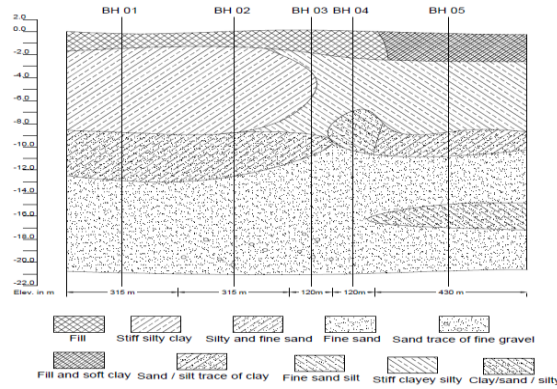

Figure 10: The soil profile at places of slope failure the Abu Homs drain

Method (A) of Protection

The Drainage Research Institute has provided a method of protection which does not result in any negative effects either on the left embankment of the drain or the right embankment and the railway lines, it was geotextiles filled with sand. Figure 11



Figure 11: Pictures of some projects implemented with geotextile bags reinforcing the tendencies of the channels

The design method was based on reducing the water duty to 17 m³ / f / day instead of 33 m³ / f / day, resulting in a reduction of the water sector area and a decrease in the width of the design bed by one meter on average. The drain axis has been moved to the right side by a reduction in the bed width of one meter on average, which will help to increase the stability of the railway

Stages of the method:

Sacks made of geotextile are prepared with the following specifications:

Material polyester or high-density polypropylene with a thickness of at least 1.7 mm. It weighs not less than 311 gram/ m² and is not affected by weather factors and is not attractive to rodents. Its dimensions are (100 * 50 * 25) cm; Fill it with dry, white sand without salts or substances. Strange or sharp edged (The weight of the bag intended for use is about 275 kg, sacks supplied with hands for lifting and loading are manufactured in a way that allows safe lifting, unloading and movement.

- Two layers of sacks are placed on the current surface on the left berm of the drain (A1: A4) and topped by B1: B3. (They constitute a weight of 0.550 tons / m². Figure 12

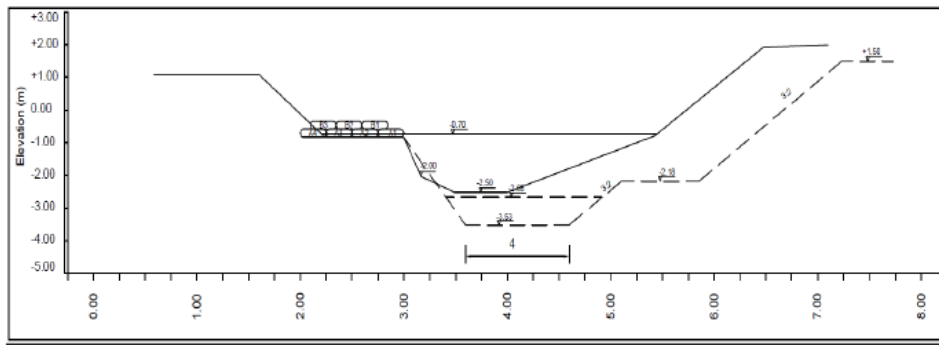

Figure 12: first stages of method A protection of slope failure the Abu Homs drain

After two days, three layers of sacks are added to the previous layer (C1: C4, and E1: E3). Then drilling work is done adjacent to the bags A1: A4 with a mechanical drill to form the sides of the drain with depth Suffice to slide the sacks group A, B (noting that the sacks movement. It will be tilted down and to the entrances to the axis of the drain.

After two days, three layers of sacks are added to the previous layer (F1: F4, up to G1: G3), Then drilling work is done adjacent to the sacks in rows A to D with a mechanical drill to form sides The drain is deep enough to slide the stack of sacks into rows A to D. Figure 13

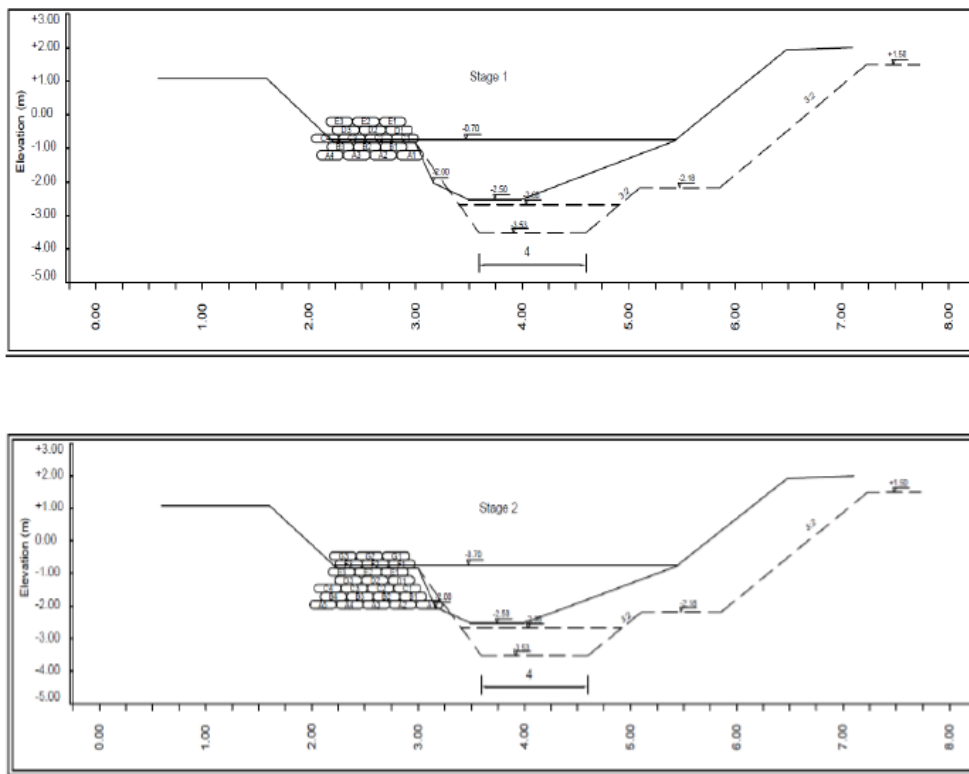

Figure 13: stages 1,2 of method A protection of slope failure the Abu Homs drain

After two days, three layers of sacks are added to the previous layer (H1: H4, up to I1: I3). Then drilling is done adjacent to the sacks in rows A to D with a mechanical digger to form sides. The drain is deep enough to slide the set of sacks into rows A through G. After two days, three layers of sacks are added to the previous layer (J1: J4, up to K1: K3). Then drilling is done adjacent to the bags in rows A to D with a mechanical digger to form sides. The drain is deep

enough to slide the set of sacks into rows A through I. Drilling work adjacent to the sacks in rows A to D is done by a mechanical drill to form sides the drain is deep enough to slide the stack of sacks into rows A to I and

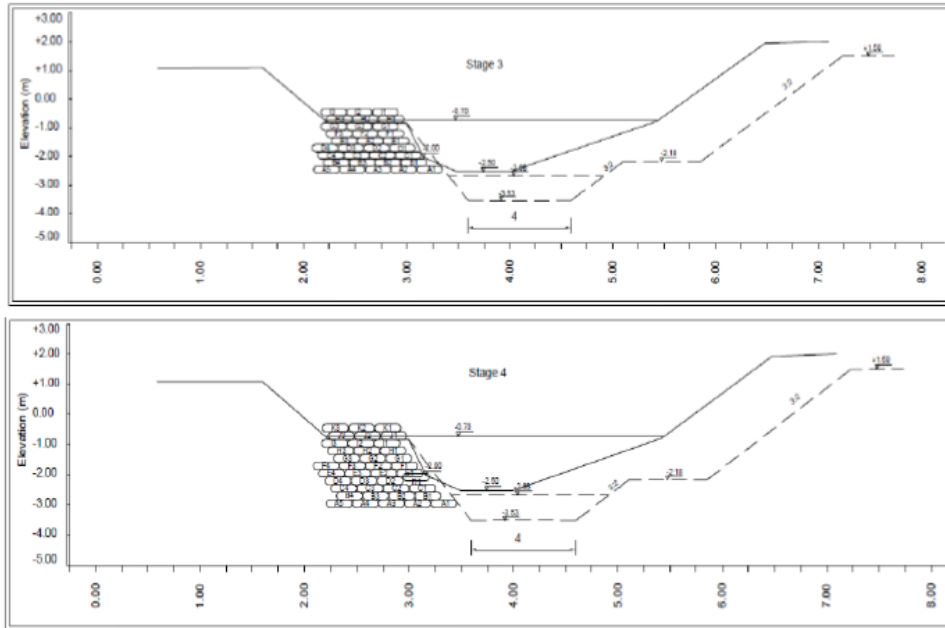

Figure 14: stages 3,4 method of A protection of slope failure the Abu Homs drain

Continue work until the level of the row of sacks A, below the design bed level of the drain, stabilizes and becomes a shape. The group of sacks has approached the natural inclination of the drain with its left embankment) and not the design slope that was (2:3), Figure 15

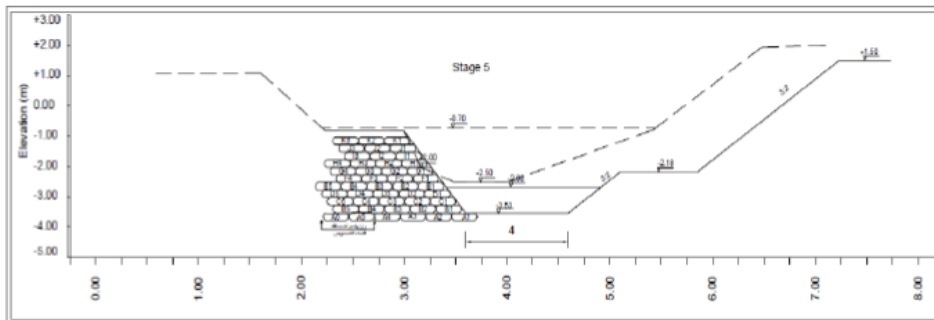

Figure 15: stages 5 method A of protection of slope failure the Abu Homs drain

Advantages and disadvantages of this method

Reducing the drain sector and water duty is a defect in the formation of protection whose function is to maintain the design sector without change. Changing the drain axis that may cause erosion of the manufactured embankment is a defect. The complex implementation method, which needs high precision in implementation due to its many details, and is not considered a permanent and continuous solution. The most important advantage is cost and speed, and is considered a temporary solution.

Method (B) of Protection

protection method b has been proposed to preserve the drain sector unchanged, as well as the water duty, taking into account the appropriate cost.



Figure 16: Pictures of some projects implemented with **Soldier Pile Walls**

It consists of aligning mechanical Strauss piles with a diameter of 0.40 m at distances from 2.5 to 3.0 m with a depth of not less than one and a half times the free length of the pile with an armament of 8 Ø 16 and spirals strips every 0.15 m. Connected by a pile cap from the top with a thickness of 0.50 m and a width of 1.20 m. A curtain wall with a thickness of 0.25 hangs from it and its height is not less than 1.0 m. A rip rap with a thickness of 0.50 m is formed above it, reaching the road level, and above it plan concrete beam a thickness of 0.2 m. And installing filters behind the rip rap at the seepage line with clean soil backfilling with gravel behind the failure, as shown in Figure 17, 18.

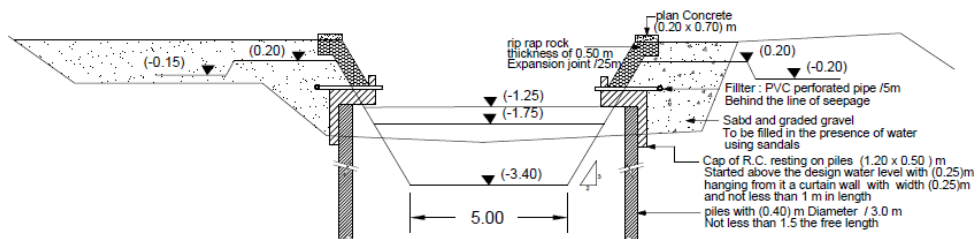

Figure 17: section of Method (B) of Protection of slope failure the Abu Homs drain

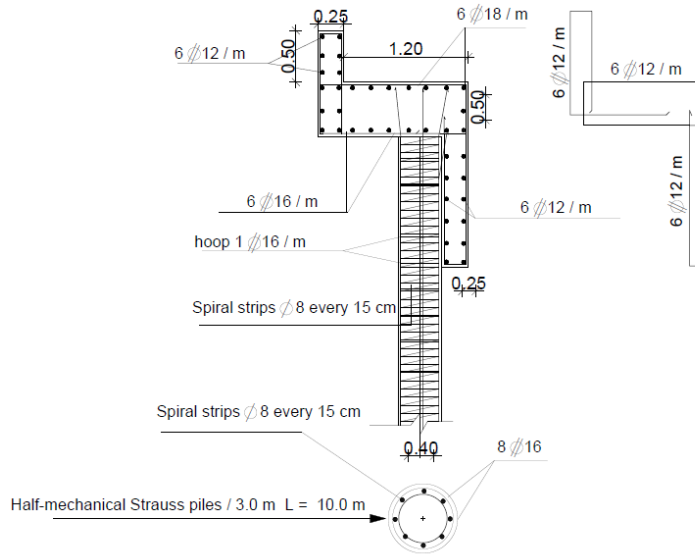

Figure 18: section(A-A) of Method (B) of Protection of slope failure the Abu Homs drain

Advantages and disadvantages of this method

This method was not feasible as it was previously implemented in some failure places and there was a collapse of the sector where the piles slipped their great spacing as shown in the Figure 19



Figure 19: section(A-A) of Method (B) of Protection of slope failure the Abu Homs drain

Method (C) of Protection

At places of failure an another mechanical rotary poring samples taken at a depth of 20 meters, and disturbing and non-disturbing samples were extracted for each one accumulated in the soil profile. Figure 20

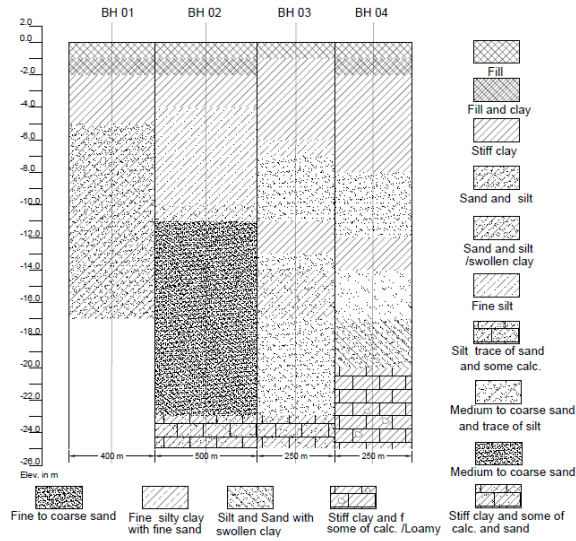

Figure 20: Another soil profile at places of slope failure the Abu Homs drain

The Wall App. program was used to simulate the safety parameters and determine the different values of torque and expected bending of the wall and it ended to:
 A half mechanical Strauss piles of a diameter of 0.50 m every 1.25 m and a length of 15 m reinforcement of 10 Ø 16 mm and spirals strips every 0.12 m
 Connected by a pile cap beam from the top with a thickness of (0.50 x 0.70) hanging from it a curtain wall according to the drawings of the figure 21,22.

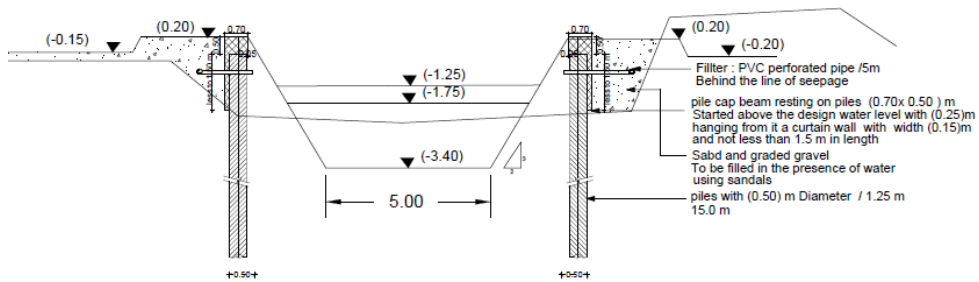

Figure 21: Another soil profile at places of slope failure the Abu Homs drain

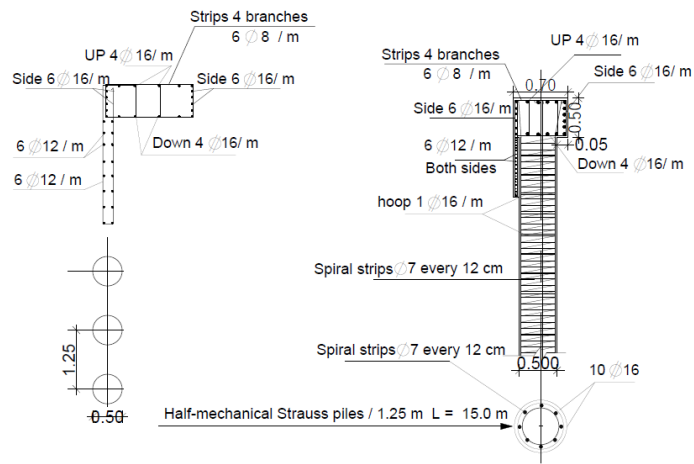

Figure 22: Another soil profile at places of slope failure the Abu Homs drain

Stages of the method:



Figure 23: stages 1,2 of method C protection of slope failure the Abu Homs drain



Figure 24 stages 3,4of method C protection of slope failure the Abu Homs drain

Advantages and disadvantages of this method

It was sufficiently safe, limits infringements, and preserved the water regulation and the shape of the strip, but its cost is high. It has been applied to many drains in other governorates, and has been circulated at the authority's level .It is the most effective method.



Figure 25: Izbet Al-Tawala sector, before & after protection works from google earth



Figure 25: Izbet Al-zewil sector, before & after protection works from google earth

Conclusions

There is no doubt that a good study and an appropriate analysis of the problem side slope failures of drains, is the main factor in reaching the appropriate protection method

And using piles with curtain wall has become the easiest solution without venturing to find a new idea that gives the same results at a lower cost

Each sector must be dealt with separately by taking soil samples at the site itself and studying it independently.

References

- [1] British Standards Institution (1957), "British Standards Code of Practice, CP2001, Site Investigation" pp. 26.
- [2] Budhu, M., Gobin, R. (1996), "Slope Instability From Ground-Water Seepage", Journal of Hydraulic Engineering, ASCE, Vol. 122, No. 7, July, pp. 415-417.
- [3] Burgi, P.H., Karaki, A. (1971), "Seepage Effect on Channel Bank Stability", Journal of the Irrigation and drainage division, ASCE, Vol. 97, IR 1, March, pp. 59-72.
- [4] Cedergren, H.R. (1977), "Seepage, Drainage, and Flow net", Second edition, A Wiley-Interscience Publication, John Wiley and Sons.
- [5] Chow, Y.K. (1996), "Analysis of piles Used for Slope Stabilization", International Journal for Numerical and Analytical Methods in Geomechanics, Vol. 20, pp. 635-646.
- [6] DeBeer, E.E., Wallays, M. (1970), "Stabilization of a Slope in Schist by Means of Bored Piles Reinforced with Steel Beams", Proceedings of 2nd International Congress on Rock Mechanics, Vol. 03, pp. 361-369
- [7] El-Ashaal, A.A., Abdel-Motaleb, A.A., and ElKholly, S.M. (2003), "Upgrading and Reconstruction of a Collapsed Embankment Founded on Salty Soil", Dam Maintenance and Rehabilitation, Lianos et al. (eds), pp. 763- 768
- [8] El-Ashaal, A., Abdel-Motaleb, A., and Haggag, H. (2000), "Stabilizing Embankments Made of and Founded Over Weak Soil Using Piles: A Case History", Proceedings of the Fourth International Engineering Conference, Cairo University, Cairo, Egypt, pp. 415-426
- [9] El-Ashaal, A.A., Hikal, A.H., and Abdel-Motaleb, A.A. (2000), "Rehabilitation and Upgrading of a Zoned Fill Dike", Soil Mechanics and Foundation, Journal of the Egyptian Geotechnical Society, Vol. 11, Part 2, December, pp. 97-116
- [10] Govindaraju, R. S. (1998), "Effect of Erosion Parameters for Soil Slopes with Stability Varying Properties" Journal of Irrigation and Drainage Engineering, ASCE, Vol. 124, No. 2, March/April, pp. 81-88